

## DISPLAY

590

ROUND

T2, T5, HALOGEN, XENON

- extruded aluminum construction
- available in linear fluorescent or low-voltage incandescent lamps
- low-voltage lamps may be spaced 12", 9" or 6" on center
- two types of housing for remote ballast/transformer
- fixtures are built to order with lengths to the nearest 1/16"
- available in many anodized and powdercoated finishes. contact the factory for options
- all Display fixtures come standard with 9'-0" wire leads
- two types of wire feed offered  
**End Feed** includes 6'-0" of 3/8" flexible conduit  
**Front Feed** includes a matching 32" long 1/2" o.d. rigid downtube and 3'-0" of 3/8" flexible conduit
- optional mounting clips, end caps and lamp sleeves
- UL and C-UL Listed for Dry and Damp Locations

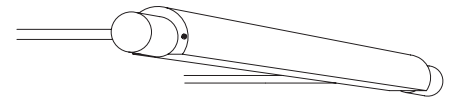
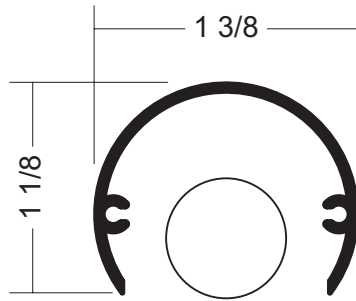

Rotating Arm Bracket  
option: **RAB**  
See Custom-p2 for details

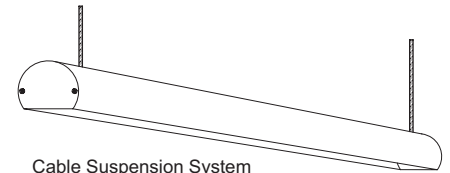

Cable Suspension System  
option: **CSS**  
See Custom-p1 for details

### End Caps Available for Model 590



Solid End Cap  
option: **EC590A**

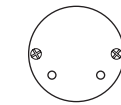

End-Mount  
End Cap  
option: **EC590B**

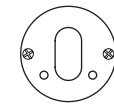

Feed-Through  
End Cap  
option: **EC590C**

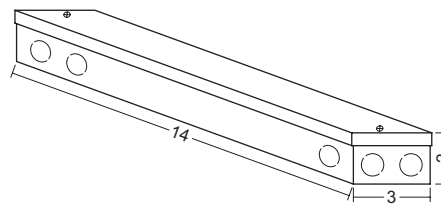

Remote Power Box  
**BB14B**  
concealed mount

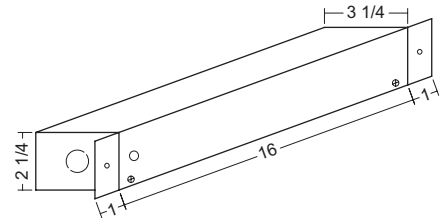

Remote Power Box  
**BB16A**  
flush mount

Job Information	
Type	_____
Job Name	_____
Location	_____

590

Reflector Shape

Lamp Type

T2  
T5  
T5HO  
H10 - 10 watt halogen  
H20 - 20 watt halogen  
X10 - 10 watt xenon  
X20 - 20 watt xenon  
*when specifying halogen or xenon, add 12, 9 or 6 for lamp on-center spacing*

Remote Power Box  
BB14B  
BB16A

Voltage

120  
277  
347  
UNV

Length  
specify required length to the nearest 1/16"

Finish  
specify required finish

Options

Feed Type  
EFR - End Feed Right  
EFL - End Feed Left  
FFR - Front Feed Right  
FFL - Front Feed Left  
CU - custom (supply sketch)  
"Right" is shown above

# BIRCHWOOD LIGHTING

714.550.7118 • fax 714.550.7151 • www.BirchwoodLighting.com

NOTE: Specifications and dimensions are subject to change without notice.

