

WP SYSTEM

WP-T2-S

STANDARD

T2 SUBMINIATURE LAMP

- 20 gauge steel construction, also available in aluminum, add "AL" in "Options" space
- uses subminiature T2 fluorescent lamps, other lamp types available
- standard ballasts are integral electronic
- long runs are tandem wired with the master-satellite configuration unless otherwise specified
- fixtures are available in nominal lengths of 1, 2, 3 and 4 feet, see part numbers to the right for actual fixture lengths
- standard finish is High Reflectivity White powder coat done post production, decorative Large Pattern Galvanize and other custom colors and finishes are also available
all WP System fixtures are treated with a multi-stage phosphate process which ensures proper finish bonding and inhibits rust
- optional standard (shown) and custom shape solid, slotted or perforated reflectors available
- UL and C-UL Listed for Dry and Damp Locations

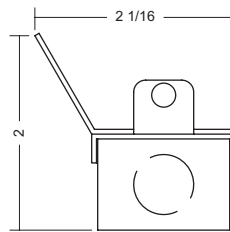
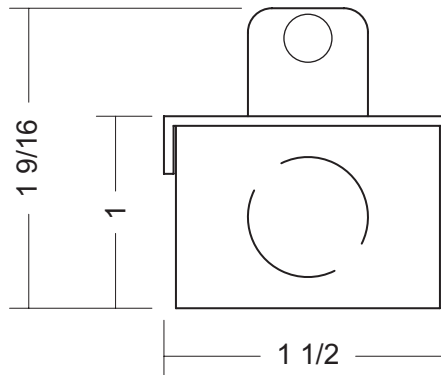

ASYMMETRIC REFLECTOR
TYPE 1
option: AR1

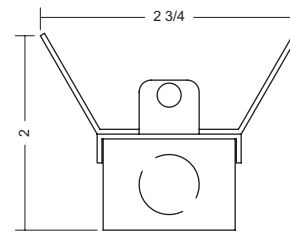

SYMMETRIC REFLECTOR
option: SR

Job Information
Type _____
Job Name _____
Location _____

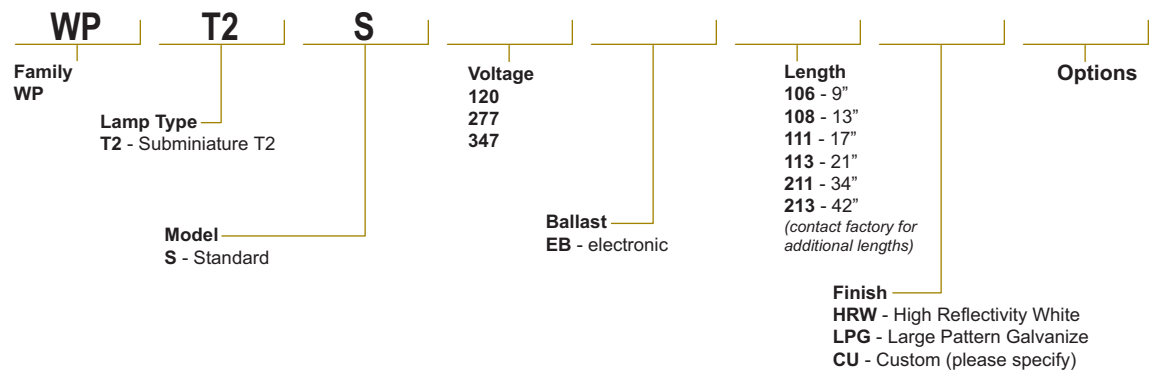

BIRCHWOOD LIGHTING

714.550.7118 • fax 714.550.7151 • www.BirchwoodLighting.com

NOTE: Specifications and dimensions are subject to change without notice.



WP SYSTEM

WP-T2-LP

LOW-PROFILE

T2 SUBMINIATURE LAMP

- 20 gauge steel construction, also available in aluminum, add "AL" in "Options" space
- uses subminiature T2 fluorescent lamps, other lamp types available
- standard ballasts are remote electronic, see drawings for remote ballast housing options
- fixtures come standard with 9'-0" wire leads and special 3/8" flex connector
- fixtures are available in nominal lengths of 1, 2, 3 and 4 feet, see part numbers to the right for actual fixture lengths
- standard finish is High Reflectivity White powder coat done post production, decorative Large Pattern Galvanize and other custom colors and finishes are also available
all WP System fixtures are treated with a multi-stage phosphate process which ensures proper finish bonding and inhibits rust
- optional standard (shown) and custom shape solid, slotted or perforated reflectors available
- UL and C-UL Listed for Dry and Damp Locations

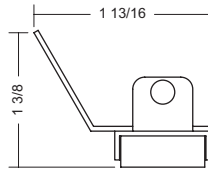
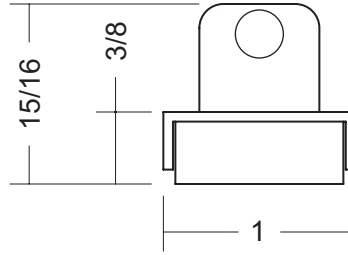

ASYMMETRIC REFLECTOR
TYPE 1
option: AR1

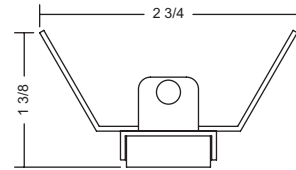

SYMMETRIC REFLECTOR
option: SR

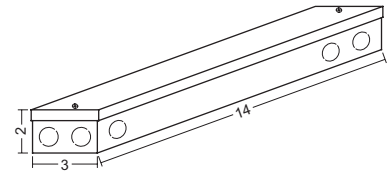
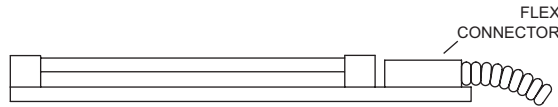

"LP" fixtures come standard with "BB14B" remote ballast box. Other ballast box types available, see ballast box catalog sheet.

Job Information	
Type	_____
Job Name	_____
Location	_____

WP	T2	LP	Voltage	Length	Options
Family WP	Lamp Type T2 - Subminiature T2	Model LP - Low-Profile	120 277 347	106 - 11 1/2" 108 - 15 1/2" 111 - 19 1/2" 113 - 23 1/2" 211 - 36 1/2" 213 - 44 1/2" <i>(211 & 213 are made up of two lamps end-to-end)</i>	Ballast EB - electronic Finish HRW - High Reflectivity White LPG - Large Pattern Galvanize CU - Custom (please specify)

BIRCHWOOD LIGHTING

714.550.7118 • fax 714.550.7151 • www.BirchwoodLighting.com

NOTE: Specifications and dimensions are subject to change without notice.

