

WP SYSTEM

WP-40T-S

STANDARD

40W LONG TWIN-TUBE LAMP

- .050 aluminum construction, also available in steel, add "ST" in "Options" space
- 40 watt 2G11 long twin-tube compact fluorescent lamps, other lamp types available
- standard ballasts are integral electronic, consult factory for available types of dimming and emergency ballasts
- long runs are tandem wired with the master-satellite configuration unless otherwise specified
- fixtures are available in single and multiple lamp units, see part numbers to the right for actual fixture lengths
- standard finish is High Reflectivity White, Satin Anodized, decorative Large Pattern Galvanize and other custom colors and finishes are also available
all WP System fixtures are treated with a multi-stage phosphate process which ensures proper finish bonding and inhibits rust
- optional standard (shown) and custom shape solid, slotted or perforated reflectors available
- UL and C-UL Listed for Dry and Damp Locations

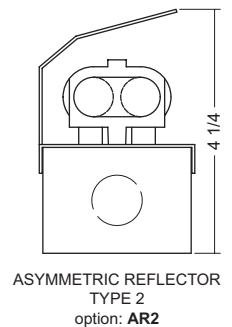
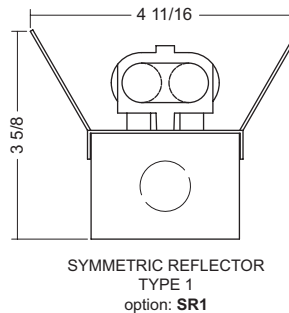
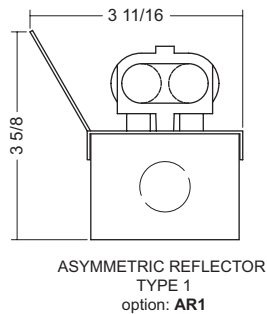
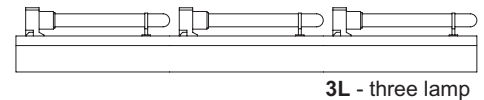
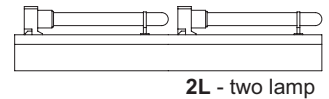
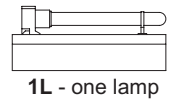
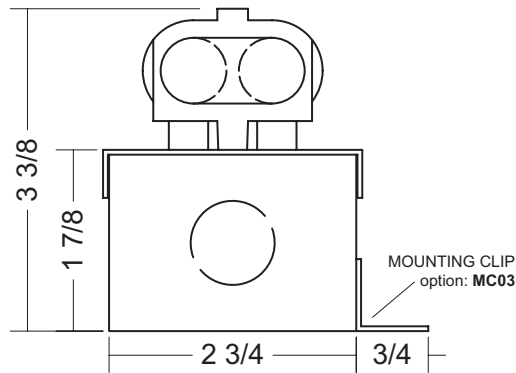

Job Information
Type _____
Job Name _____
Location _____

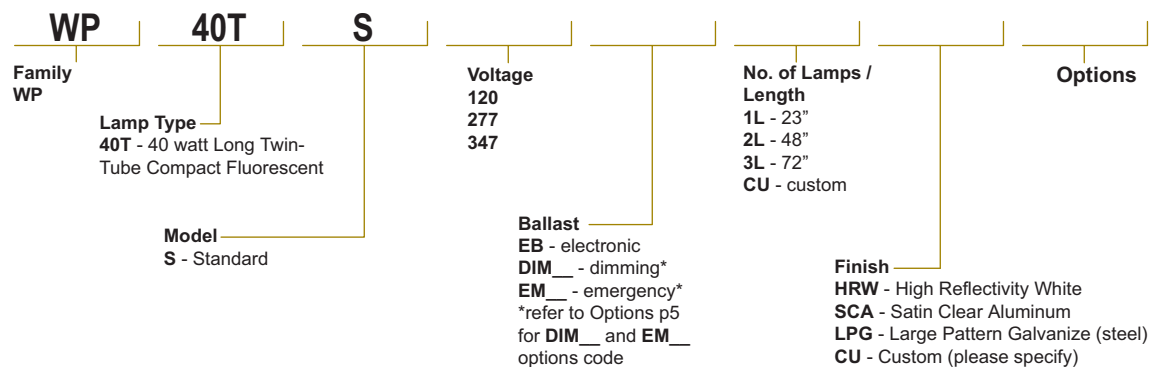

BIRCHWOOD LIGHTING

714.550.7118 • fax 714.550.7151 • www.BirchwoodLighting.com

NOTE: Specifications and dimensions are subject to change without notice.

