

510 LED DISPLAY

QUARTER ROUND

HIGH LUMEN LED EMITTERS

RB - REMOTE BALLAST

- light engines available:
 - HF2N High Lumen LED emitters
 - HF2N-H Half populated
 - HF2XB-S4 high lumen LED emitters
- extruded aluminum housing -excellent heat sinking - extends lamp life - improves efficiency
- all display fixtures come standard with 9'-0" wire leads
- satin anodized clear finish is standard - a variety of other standard and custom finishes and powdercoated finishes are available
- remote driver
- mounting options, end caps, and acrylic diffusers also available
- UL and C-UL listed for dry and damp locations

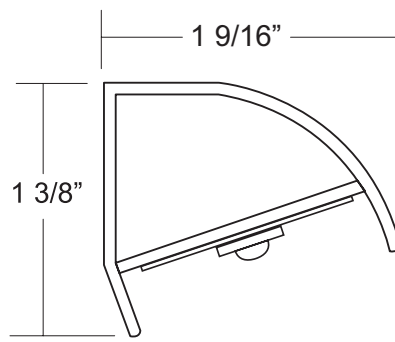

510-LED dimensions

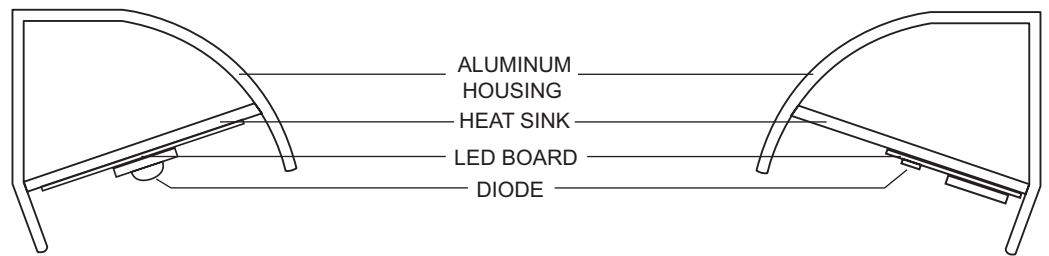

-HF2XB-S4
(11.5" boards)

-HF2N
(10" & 4" boards)

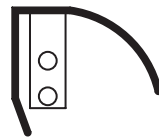

Flush-Mount / Wood-End
Mounting Clip
option: **MC01**

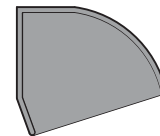

Smooth Finish
Matching Solid End Cap
option: **EC510**

510-LED

560-LED

LED Options:
-HF2N
(10w/ ft)
-HF2N-H
(5w/ ft)
-HF2XB-S4
(3.9w/ ft)

Color Temp
-3000
-3500
-4000

Nominal Length
1 - 1'
2 - 2'
3 - 3'
4 - 4'
5 - 5'

CU - Custom*
CR_** - Continuous Run*

*Consult Factory
**Specify length in nominal feet

Voltage
1 - 120V
2 - 277V

Mounting
-MC01
-Custom*

Lens

NL - No Lens
SIC - Satin Ice Clear
SIW - Satin Ice White
LP - Linear Prismatic**
CU - Custom*

*Consult Factory
**Non-stocked item - longer lead time

Feed Type

EFR - End Feed Right
EFL - End Feed Left
FFR - Front Feed Right
FFL - Front Feed Left
CU - custom (supply sketch)
*Right" is shown above

Finish
SC - Satin Clear
BC - Bright Clear
FB - Flat Black
CU - Custom*

*Consult Factory

Options*

*Specify or consult factory

Job Information

Type:

Job Name:

Location:

BIRCHWOOD LIGHTING

714.550.7118 • fax 714.550.7151 • www.BirchwoodLighting.com

NOTE: Specifications and dimensions are subject to change without notice.

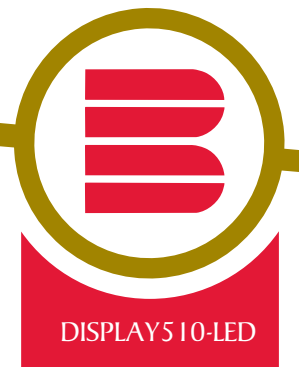

DISPLAYS 510-LED

560 LED DISPLAY

LOW PROFILE

SHOWCASE / DISPLAY

RB - REMOTE BALLAST

- light engines available:
 - HF2N High Lumen LED emitters
 - HF2N-H Half populated
 - HF2XB-S4 high lumen LED emitters
- extruded aluminum housing -excellent heat sinking - extends lamp life - improves efficiency
- all 560-RB fixtures come standard with 9'-0" wire leads
- variety of lensing options
- satin anodized clear finish is standard - a variety of other standard and custom finishes and powdercoated finishes are available
- remote driver
- mounting options, end caps, and acrylic diffusers also available
- UL and C-UL listed for dry and damp locations

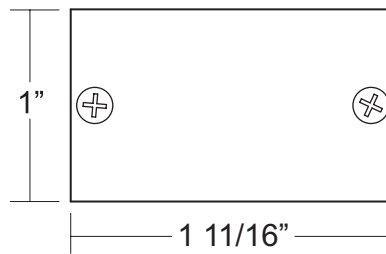

560-LED dimensions

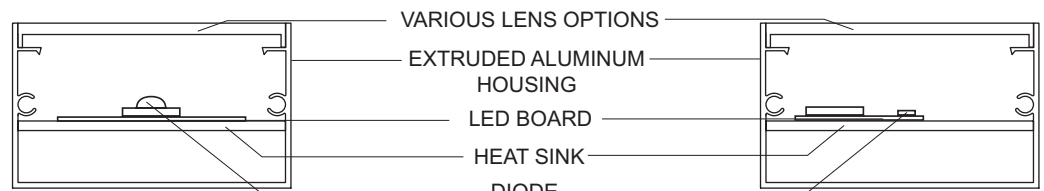

-HF2XB-S4
(11.5" board)

-HF2N
-HF2N-H
(10" & 4" boards)

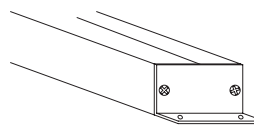

Mounting Clip
option: **MC04**

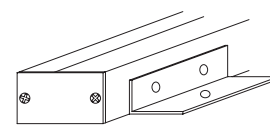

Mounting Clip
option: **MC03**

560-LED

560-LED

LED

Options:
-HF2N
(10w/ ft)
-HF2N-H
(5w/ ft)
-HF2XB-S4
(3.9w/ ft)

Color

Temp
-3000
-3500
-4000

Nominal

Length
1 - 1'
2 - 2'
3 - 3'
4 - 4'
5 - 5'
CU - Custom*
CR_** - Continuous
Run*

*Consult Factory
**Specify length
in nominal feet

Voltage

1 - 120V
2 - 277V

Mounting
-MC03
-MC04
-Custom*

Lens

NL - No Lens
SIC - Satin Ice Clear
SIW - Satin Ice White
LP - Linear Prismatic**
CU - Custom*

*Consult Factory
**Non-stocked item -
longer lead time

Feed Type
EF - End Feed
BF - Back Feed
CU - custom
(supply sketch)

Finish

SC - Satin Clear
BC - Bright Clear*Specify or
consult factory
FB - Flat Black
CU - Custom*

*Consult Factory

Options*

*Specify or
consult factory

Job Information

Type:

Job Name:

Location:

BIRCHWOOD LIGHTING

714.550.7118 • fax 714.550.7151 • www.BirchwoodLighting.com

NOTE: Specifications and dimensions are subject to change without notice.



DISPLAY560-LED

595 LED - DISPLAY

ANGLED

SHOWCASE / DISPLAY

RB - REMOTE BALLAST

- light engines available:
 - HF2N High Lumen LED emitters
 - HF2N-H Half populated
 - HF2XB-S4 high lumen LED emitters
- extruded aluminum housing
 - excellent heat sinking - extends lamp life - improves efficiency
- variety of lensing options
- satin anodized clear finish is standard - a variety of other standard and custom finishes and powdercoated finishes are available
- all display fixtures come standard with 9'-0" wire leads
- remote driver
- mounting options, end caps, and acrylic diffusers also available
- UL and C-UL listed for dry and damp locations

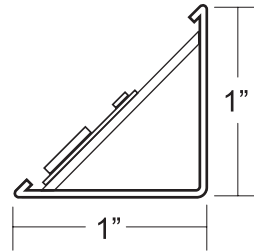

595-LED dimensions

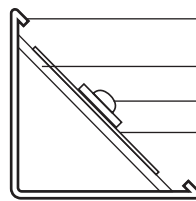

-HF2XB-S4
(11.5" boards)

ALUMINUM HOUSING
HEAT SINK
DIODE
LED BOARD

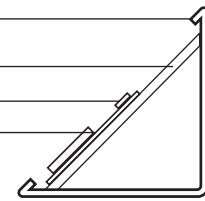

-HF2N
(10" & 4" boards)

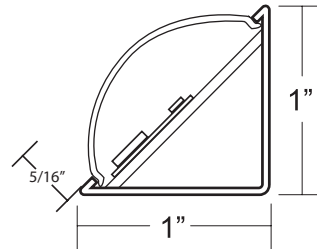

(SIW) Satin Ice White Lens Option

595-LED

595-LED

LED

Options:
-HF2N
(10w/ ft)
-HF2N-H
(5w/ ft)
-HF2XB-S4
(3.9w/ ft)

Color Temp
-3000
-3500
-4000

Nominal Length
1 - 1'
2 - 2'
3 - 3'
4 - 4'
5 - 5'

CU - Custom*
CR** - Continuous Run*

*Consult Factory
**Specify length in nominal feet

Voltage
1 - 120V
2 - 277V

Feed Type

EF - End Feed
FF - Front Feed
CU - custom (supply sketch)

Lens

NL - No Lens
SIC - Satin Ice Clear
SIW - Satin Ice White
LP - Linear Prismatic**
CU - Custom*

*Consult Factory
**Non-stocked item - longer lead time

Finish
SC - Satin Clear
HRW - High Reflective White
FB - Flat Black
CU - Custom*

*Consult Factory

Options*

*Specify or consult factory

Job Information

Type:

Job Name:

Location:

BIRCHWOOD LIGHTING

714.550.7118 • fax 714.550.7151 • www.BirchwoodLighting.com

NOTE: Specifications and dimensions are subject to change without notice.



DISPLAY595-LED

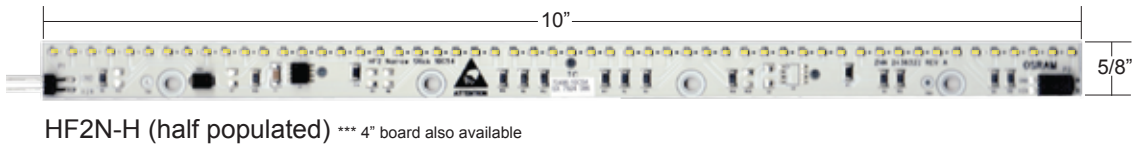
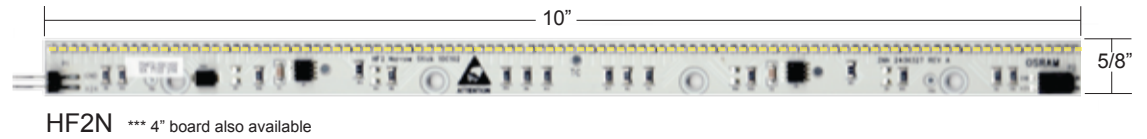
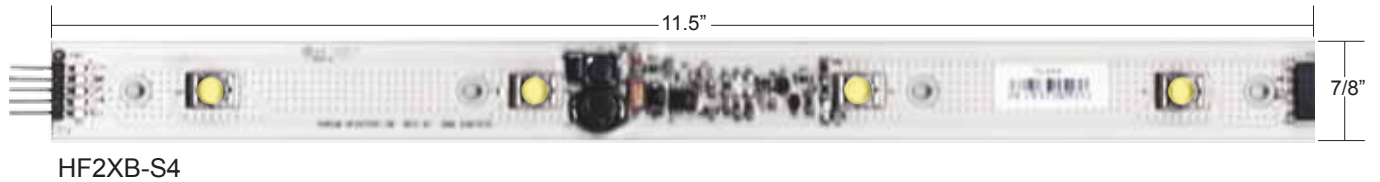

LED LIGHT ENGINE SPECS

LED OPTIONS

- Light engines available:
 - HF2N - 102 emitters on 10" - 10 watts/ft. 540 lumens/ft.
 - HF2N-H - 54 emitters on 10" 5 watts/ft. 270 lumens/ft.
 - HF2XB-S4 - 4 emitters on 11.5" 3.9 watts/ft. 225 lumens/ft.
- please consult factory for other options
- continuous run with several boards
- remote driver required: *see driver housing page *consult factory for driver options
- UL and C-UL listed for Dry and Damp locations

HF2N

- Narrow 5/8" w board comprized with closely packed small LEDs
- High Lumen LED emitters with rated service life to 50,000 hours at 65 degrees Celsius.
- HF2N modules come in 10" and 4" sections with 102 emitters on the 10" and 42 emitters on the 4" section near continous light. 10 watts/ft. yielding 540 lumens/ft. which is 54 lumens/watt (lumen/ft. and lumens/watt based on 3000K color temp)
- Available in 3000K, 3500K and 4000K
- 120 degree beam angle
- CRI 85
- 4" boards also available* contact factory

HF2N-H (half populated)

- Narrow 5/8" w board comprized with closely packed small LEDs
- High Lumen LED emitters with rated service life to 50,000 hours at 65 degrees Celsius.
- HF2N-H modules is half populated which in turn uses half the wattage and the operating temp is less than the full population
- HF2N-H modules come in 10" and 4" sections with 54 emitters on the 10" and 24 emitters on the 4" section near continous light. 5 watts/ft. yielding 270 lumens/ft. which is 54 lumens/watt (lumen/ft. and lumens/watt based on 3000K color temp)
- Available in 3000K, 3500K and 4000K
- 120 degree beam angle
- CRI 85
- 4" boards also available* contact factory

HF2XB-S4

- High Lumen LED emitters with rated service life to 50,000 hours at 40 degrees Celsius.
- HF2XB-S4 modules come in 11.5" lengths with 4 emitters per module 3.9 watts/ft. yielding 225 lumens/ft. which is 58 lumens/watt (lumen/ft. and lumens/watt based on 3000K color temp)
- Available in 3000K, 3500K and 4100K, and 5700K
- 90 degree beam angle
- HF2XB-S4 modules run on 24VDC power
- CRI 85

Job Information

Type: _____

Job Name: _____

Location: _____

BIRCHWOOD LIGHTING

714.550.7118 • fax 714.550.7151 • www.BirchwoodLighting.com

NOTE: Specifications and dimensions are subject to change without notice.



OPT-LED

DRIVER HOUSINGS

REMOTE DRIVER HOUSINGS

- used for remote power supplies
- formed aluminum construction
- standard finish is mill aluminum to provide excellent heat dissipation
- custom powder coat finishes are available for visible housings (consult factory)
- standard sizes shown, custom sizes are available
- driver(s) and housing(s) dependent upon run length
- all models feature several conveniently located trade size knock-outs (K.O.'s)
- consult factory for recommended maximum remote mounting distance
- UL and C-UL Listed for Dry Locations

- **BB04C**
- used for 3-20w LED board combinations 120v only, 20 watt driver
- contact factory to verify specification
- DIMENSIONS: 4" x 4" x 2-3/16"
- **NOTE:** Contact Factory about Driver Housings to be sent out prior to electrical rough-in.

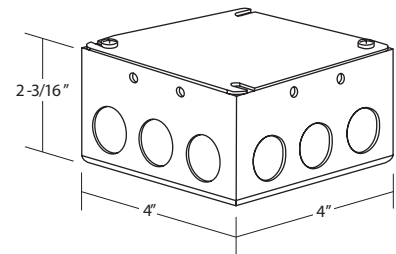

- **BB11D**
- used for 21-75w LED board combinations 120 -277v, 75 watt driver
- DIMENSIONS: 11" x 1-7/8" x 1-5/16"

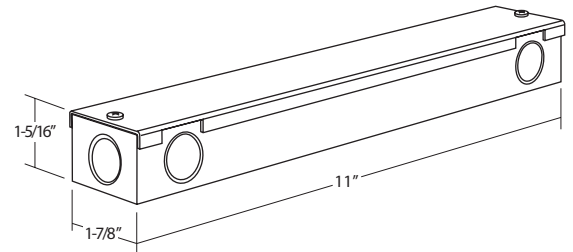

- **BB14B**
- used for 76-96w LED board combinations 120 -277v, 96 watt driver
- DIMENSIONS: 14"(L) x 3" x 2"

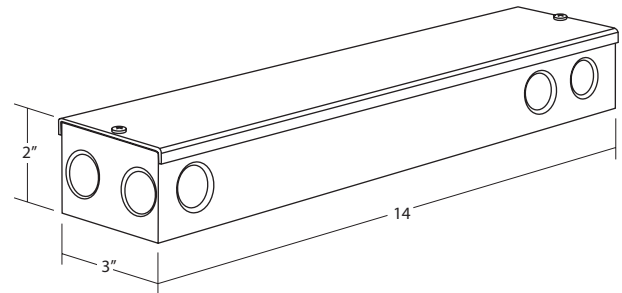

SPECIAL ORDER HOUSING

- **BB04C-MR**
- used for 3-20w LED board combinations 120v only, 20 watt driver
- contact factory to verify specification
- includes 1/2" mud ring
- *consult factory for other options
- DIMENSIONS: 4" x 4" x 2-3/16"
- **NOTE:** Contact Factory about Driver Housings to be sent out prior to electrical rough-in.

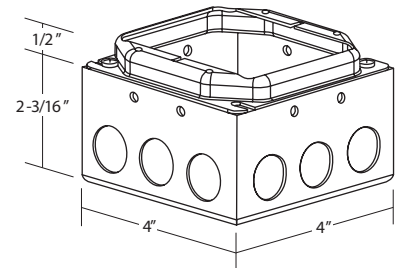

GENERAL NOTES:

- The standard Driver Housing is mill aluminum (MA) finish.
- Please contact factory for custom housing sizes and/or color
- Contact factory with any ballast housing questions

Job Information

Type:

Job Name:

Location:

BIRCHWOOD LIGHTING

714.550.7118 • fax 714.550.7151 • www.BirchwoodLighting.com

NOTE: Specifications and dimensions are subject to change without notice.



LED-DH-OPT