

BWA250

2.5" Direct/Indirect Acoustic Linear



Quality Light & Sound

The BWA250 combines exceptional sound dampening with seamless pixel-free illumination. Available with direct/indirect illumination and a sustainable housing made from 60 percent post-consumed recycled content, Birchwood acoustic luminaires offer a responsible solution for today's open spaces.

Meet the BW Acoustic

Powerful, versatile and responsible, Birchwood's acoustic product line is designed with all the modern performance expected from today's luminaires as well as industry-leading sound dampening design features.

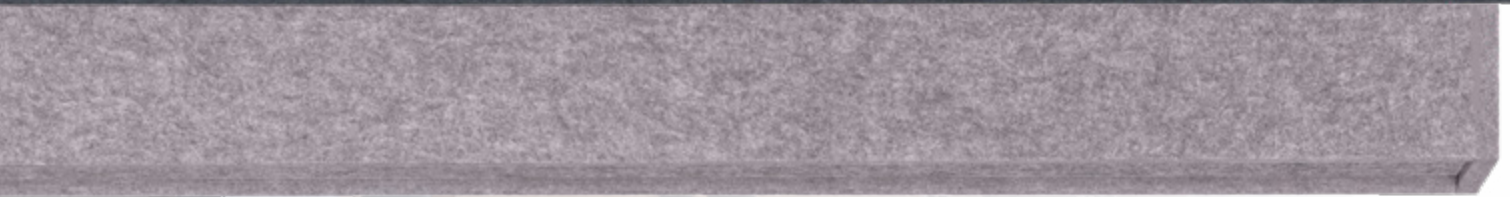

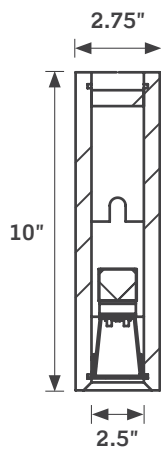
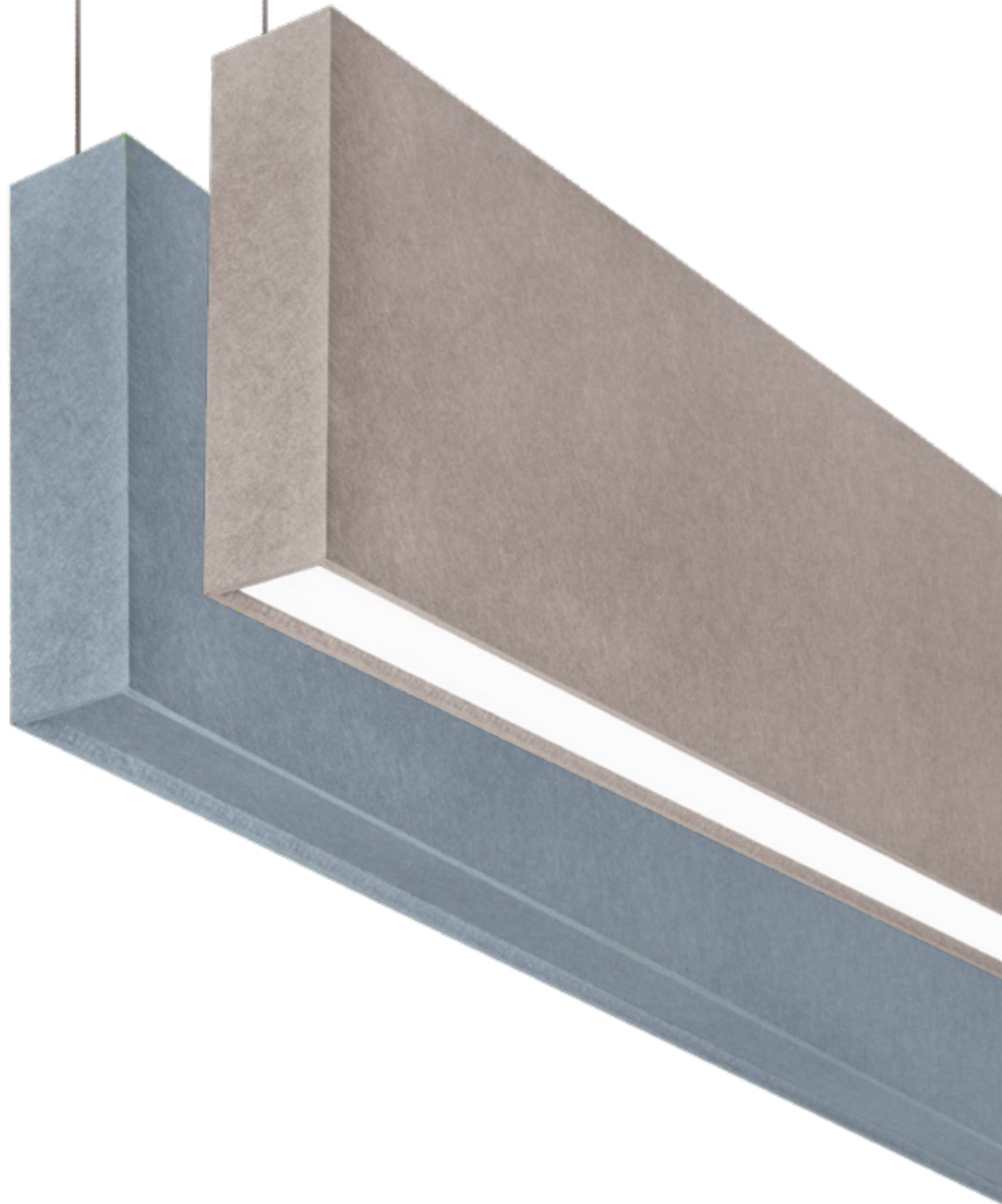

The Basics

- Available in Lit or Non-lit Configurations
- 250-900 lm/ft Efficiencies up to 94 lm/W
- Multiple Dimming Options including 0-10V, eldoLED, Lutron, & DALI
- Standard 2-Circuit Switching & Integral Driver
- Uniform Pixel-free Recessed Lensing System
- NRC Rating of 0.95

The Performance Linear System

With a vast selection of configurations, the BW Acoustic is a highly versatile and efficient luminaire. All hardware is meticulously designed to remain invisible within the acoustic covering while the Standard High Efficacy lens provides beautiful, consistent illumination.

Performance

Lumen Packages - Direct
(Nominal Delivered Lumens)

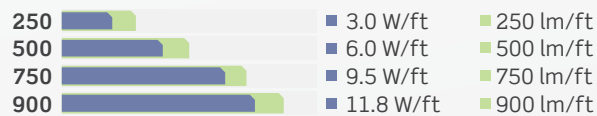

Lumen Packages - Indirect
(Nominal Delivered Lumens)

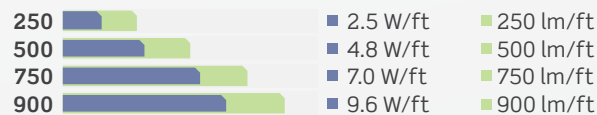

Color Consistency & Options

CCT/CRI & light source features range from 2700K to 4000K in 80/90CRI

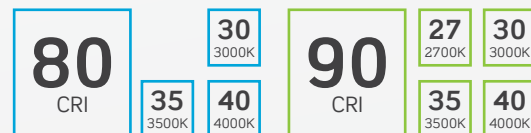

Lens & Optics

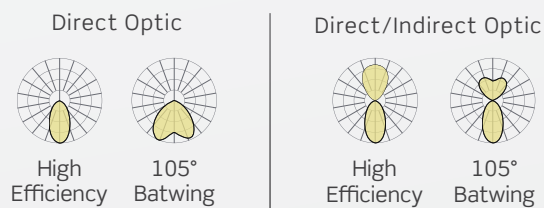

Multiple Dimming Options

- Standard 0-10V 1% Dimming, ELV, DALI, & DMXR
- Deep 0.1% Dimming Available with 0-10V, DALI or DMXR

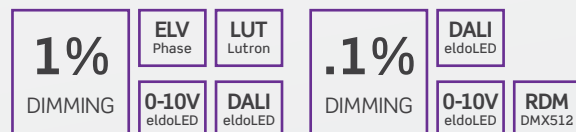

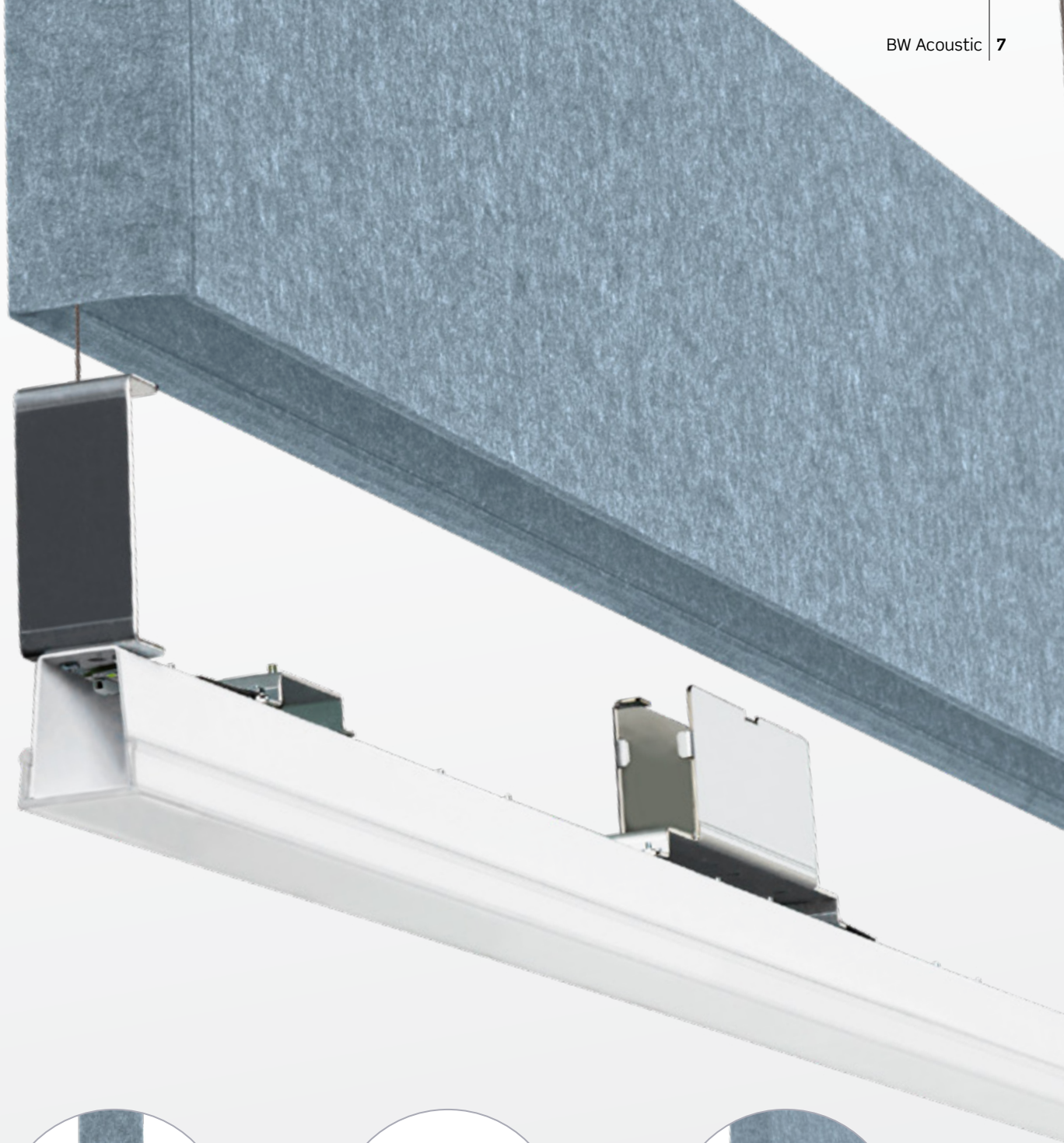

Pixel-Free Direct/Indirect
Lensing

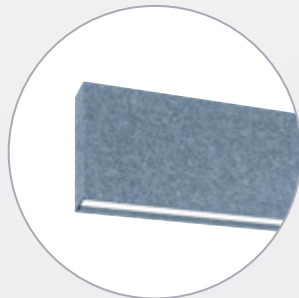

Recycled PET Felt
Acoustic Panels

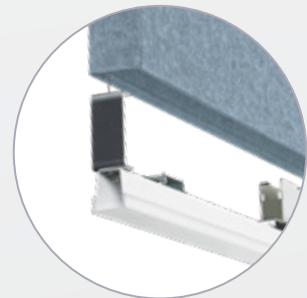

Simple & Easy
Serviceability



Acoustic Panels

Current work environments and common spaces are doing a poor job providing acoustical comfort, with acoustic problems being a key source of employee dissatisfaction in offices. Designers should aim to create spaces in accordance with comfortable reverberation times that support

intelligibility and are conducive to focus. Absorb sound by applying BW Acoustic luminaires and panels on a significant portion of the surfaces in a space. Along with superior sound absorption, bring color and texture to your space.



Noise
Reduction
Coefficient

Sound Matters

Internal and external sound influences are absorbed by the BW Acoustic material, lowering the noise level in a room. People can feel more at ease in their surroundings and have higher speech intelligibility when they are able to communicate freely without having to strive to be heard.

24-inch Spacing

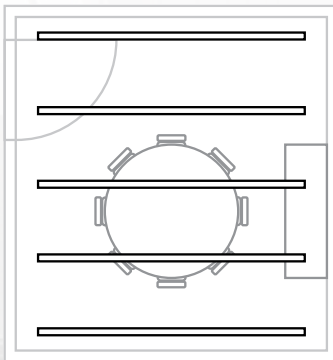

18-inch Spacing

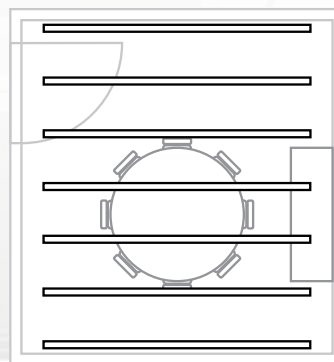

12-inch Spacing

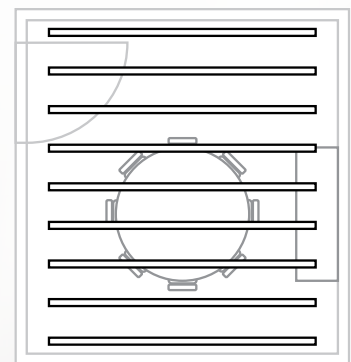

Spacing	Abs. Coefficient from Total Coverage Area (53.46 ft ²)	Abs. Coefficient from Total Exposed Surface Area (114.81 ft ²)	Abs. Coefficient from One Face per Object (44.48 ft ²)	Abs. Coefficient From Unextended Envelope Area (47.50 ft ²)	Average
24in	0.7	0.65	1.65	0.8	0.95
18in	0.85	0.6	1.55	1	1
12in	1.15	0.55	1.4	1.3	1.1



Sustainable Materials

Birchwood is committed to providing eco-friendly solutions that contribute to the well-being of our clients and planet.



60%

Post-Consumer Recycled Content From PET Bottles



35%

Pre-Consumer Recycled Content From PET Chips



5%

PLA Polyactic Acid, A Bio-Based Material

Standard Colors

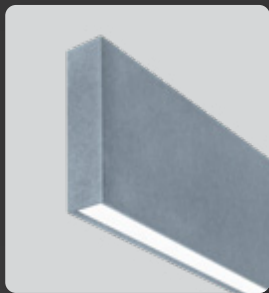

Cadet

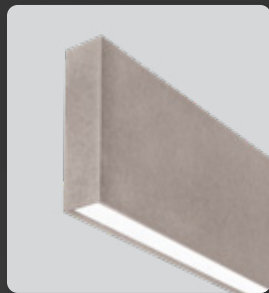

Greige

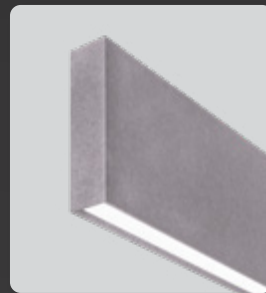

Pewter

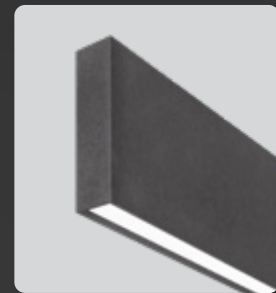

Slate

Custom Colors

(Consult Factory for Details and Lead Times)



Fossil



Sky

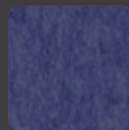

Cobalt



Malachite



Grass

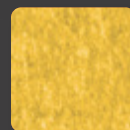

Sunshine



Mandarine

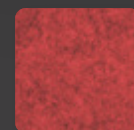

Ochre



Bark



Ecu



Linen

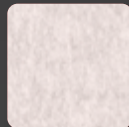

Ivory

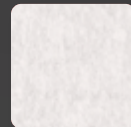

Frost



Chambray

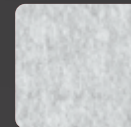

Smoke

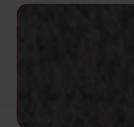

Tar

Birchwood Lighting
3340 E. La Palma Ave.
Anaheim, CA 92806

tel 714 550-7118
fax 714 550-7151

info@birchwoodlighting.com
www.birchwoodlighting.com

A Leviton Company
www.leviton.com

Printed in the U.S.A
©2022. Birchwood Lighting, LLC. All Rights Reserved.

BL2111-BWA-1

